

STEERING WHEEL CONTROL INTERFACE TO SUIT NISSAN VEHICLES

SWNI24C

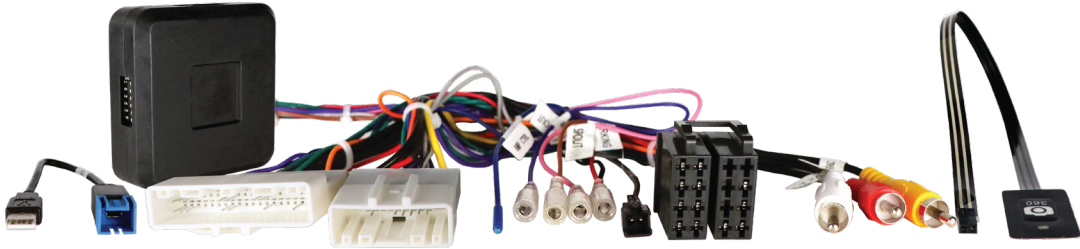

INSTALLATION GUIDE

The SWNI24C allows for the retention of the OEM 360-Degree camera system and the steering wheel controls as well as other vital features when installing an aftermarket unit into the vehicle. This interface features selectable dipswitches for dedicated applications, simply refer to the provided table for the correct configuration ensuring seamless integration.

VEHICLE APPLICATION

To Suit NISSAN

Nissan Navara	2019 -
Nissan Qashqai	2020 - 2021
Nissan X-Trail	2020 - 2022

For vehicles with 360-Degree Camera System

**does not retain 'Intelligent Park Assist'.*

KEY FEATURES

- RETAIN STEERING WHEEL CONTROL FUNCTIONALITY
- RETAINS OEM 360-DEGREE CAMERA SYSTEM
- RETAINS OEM USB INPUT
- REPLACE FACTORY RADIO
- RETAINS TIME/DATE SETTINGS
- CAN BUS INTERFACE
- OUTPUTS FOR SPEED PULSE, PARK BRAKE & REVERSE
- SOFTWARE UPDATEABLE

PRIOR TO INSTALLATION

Installation requires a certain level of technical knowledge. Prior to installation, it is important to read the manual. Select a location for installation that is dry and free from heat sources. It is essential to use the correct tools during installation to prevent any damage to the vehicle or the product itself. Please note that we cannot be held liable for any issues arising from improper installation.

Before proceeding with installation, disconnect the negative battery terminal and ensure the key is removed from the ignition.

WIRING KEY

ISO CONNECTOR WIRING KEY

Purple Right Rear Speaker +
Purple/Black Right Rear Speaker -
Green Left Rear Speaker +
Green/Black Left Rear Speaker -

Grey Right Front Speaker +
Grey/Black Right Front Speaker -
White Left Front Speaker +
White/Black Left Front Speaker -

Yellow Permanent 12V
Black Ground
Red Ignition 12V
Orange Illumination

FLYING WIRE WIRING KEY

Pink Speed Pulse - 0 to 12V Square Wave @ 1Hz/Kph
Green Park Brake

Purple/White Reverse Gear - 250mA

Red/White Acc 12V - 250mA
Yellow RCA Camera

DIPSWITCH CONFIGURATION

MANUFACTURER	SYSTEM	DIPSWITCH CONFIGURATION					CONNECTION
		1	2	3	4	5	
RESERVED	NA	OFF	OFF	OFF	OFF	OFF	SW UPDATE BOOT MODE
ALPINE	IR DATA	OFF	ON	OFF	OFF	OFF	MALE 3.5MM JACK
ANALOG SINGLE EXTEND	Analog	ON	ON	ON	ON	ON	BROWN SWC IR
ANALOG SINGLE WIRE	Analog	ON	ON	ON	OFF	ON	BROWN SWC IR
CLARION	IR DATA	ON	OFF	OFF	ON	OFF	MALE 3.5MM JACK
GRUNDIG	IR DATA	OFF	ON	OFF	ON	OFF	BROWN SWC IR
JVC	IR DATA	OFF	OFF	ON	OFF	OFF	BROWN SWC IR
KENWOOD 1	IR DATA	ON	OFF	OFF	OFF	OFF	BROWN SWC IR
KENWOOD 2	IR DATA	ON	ON	OFF	OFF	OFF	BROWN SWC IR
KEY 1 / KEY 2	Analog	OFF	ON	ON	OFF	OFF	KEY1 / KEY 2 WIRES
KEY 1 / KEY 2 EXTEND	Analog	OFF	ON	ON	ON	OFF	KEY1 / KEY 2 WIRES
PHILIPS	IR DATA	OFF	ON	OFF	ON	OFF	BROWN SWC IR
PIONEER 1	Analog	OFF	OFF	OFF	ON	ON	MALE 3.5MM JACK
PIONEER 2 / AERPRO	Analog	OFF	OFF	OFF	ON	OFF	MALE 3.5MM JACK
SONY	Analog	ON	OFF	ON	ON	OFF	MALE 3.5MM JACK
ZENEC	IR DATA	ON	ON	OFF	ON	OFF	BROWN SWC IR

KEY1 and KEY2

KEY1 and KEY2 are specifically tailored for analog learning mode-style radios. Our SWC module is designed with a resistor chain that precisely matches the required resistance for seamless compatibility with this type of head unit.

KEY1 and KEY2 EXTEND

This mode extends every button press to 2 seconds during the learning process. However, with roll wheel-designed steering wheel buttons, holding for 2 seconds isn't feasible. Our KEY1 and KEY2 extend feature addresses this by automatically prolonging each press, simplifying head unit programming even in such scenarios. Extend mode is not intended for normal use, it is only used in the teaching process.

ANALOG SINGLE WIRE and ANALOG SINGLE WIRE EXTEND

This function operates similarly to KEY1 and KEY2 but transmits all unique values through the IR SWC single wire. This is crucial for compatibility with learning-style head units featuring only one learning input wire. To ensure compatibility, we've incorporated this feature into our steering wheel control interface, ensuring seamless operation across various head unit setups. The Analog Extend mode functions identically to its counterpart within the KEY1 and KEY2 system but transmits through a single wire.

SWC INTERFACE

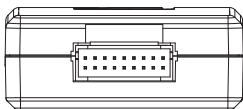

18 PIN HARNESS CONNECTOR

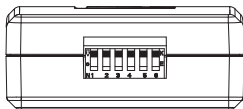

DIPSWITCHES

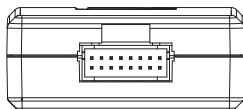

16-PIN HEAD UNIT CONNECTION LEAD



USB-C

CONNECTION GUIDE

BEFORE INSTALLATION

Prior to installing the interface, it is essential to remove and disconnect the factory stereo. For guidance on this process, please refer to the vehicle owner's manual/handbook or seek assistance from a professional.

SETTING THE DIPSWITCHES

This interface includes a set of dipswitches. Consult the dipswitch selection guide to select the appropriate configuration. To activate a dipswitch, press it downward into the 'ON' position. Refer to the diagram for an example of the 'KENWOOD' dipswitch configuration.

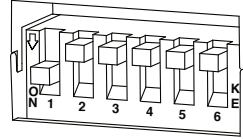

INSTALLATION

1. Take the interface, then connect the 16-PIN head unit connection lead and the 18-PIN steering wheel harness connectors to their respective ports.
2. Connect the head unit connection lead to the steering wheel remote input on the rear side of the aftermarket stereo. Connection methods vary based on the stereo brand, utilising either a 3.5mm jack connector SWC IR wire or wired inputs KEY1 and KEY2. *For specific connection guidance, refer to your aftermarket stereo's installation manual if not clearly labelled on the stereo harness.*
3. Connect the power/speaker ISO connector from the interface to the corresponding power/speaker ISO connection on the aftermarket stereo. *For aftermarket stereos lacking an ISO connector, refer to the "Wiring Key" on Page 2 for guidance on connecting wires. Certain interfaces may also include extra "flying" wires for additional functionalities such as parking brake trigger, reverse gear, and speed pulse. Further information on these wires is available in the "Flying Wire Wiring Key" section.*
4. Connect the vehicle-specific connectors from the interface harness to the corresponding connectors on the vehicle harness.
5. Connect the flying wires on the harness to the rear of the stereo (if applicable).
6. Connect the antenna adapter to the vehicle's existing connection at the rear of the aftermarket stereo.
7. When installing an aftermarket reverse camera, connect the yellow RCA from the harness to the yellow RCA of the aftermarket camera. (If supported by the interface and vehicle)
8. When installing a DAB antenna, ensure to connect the DAB aerial connector to the rear of the new stereo.
9. After connecting all wires (along with any additional accessories), it's crucial to thoroughly test the stereo and steering wheel controls before reassembling the dashboard. If steering wheel controls are unresponsive, inspect connections and check dipswitch settings. Repeat the connection process if necessary, following the outlined steps.

STEERING WHEEL CONTROL CONFIGURATION



- | | | |
|---------------|------------------|-----------|
| A Volume Up | D Track Down | G Hang Up |
| B Volume Down | E Source / Enter | |
| C Track Up | F Pick Up | |

The provided diagram, while meticulously researched, serves as an example only. Actual steering wheel control configurations may vary dependant on each vehicle.

ADJUSTING THE VEHICLE CLOCK

Enter to the vehicle's 'AUX' menu. Press and hold the "Enter" button* (E) for about 8 seconds until the clock setting screen appears. Use the "Track/Seek -" button (D) to change the hours and the "Track/Seek +" button (C) to change the minutes. Once the correct time is displayed, press the "Enter" button (E) briefly to save the settings and exit.

*If there is no 'Enter' button, press and hold 'Hang-up' (G) or 'Phone' button for 8 seconds.

CONNECTION DIAGRAM

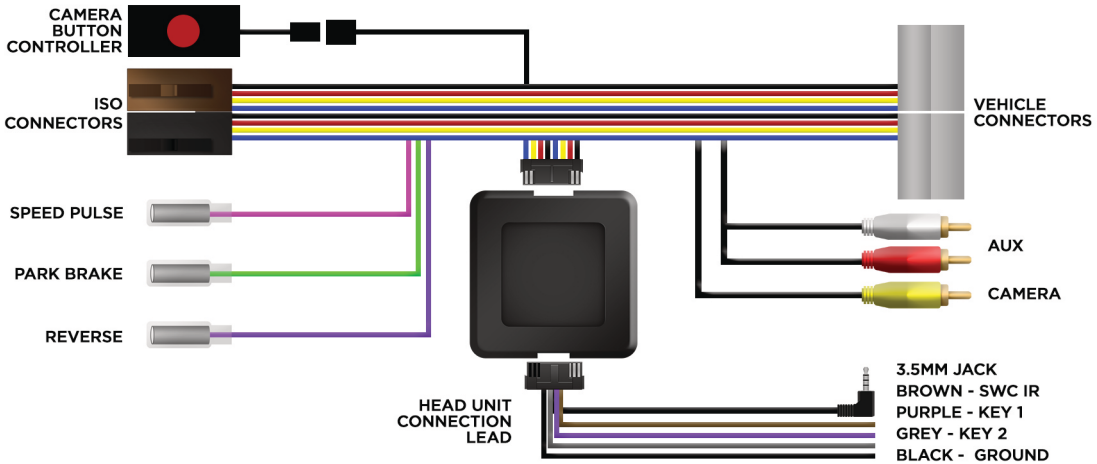

360-DEGREE CAMERA FUNCTIONALITY

ACCESS THE 360-DEGREE CAMERA

When the vehicle is not in reverse.

- Press the '360 Button Controller' briefly.
The display will show the 'front view & 360 panoramic view' (IMAGE 1).
- Press the '360 Button Controller' briefly again.
The display will switch to the 'front view & side view' (IMAGE 2).

When the vehicle is in reverse.

- Shift into reverse.
The rear view camera will appear on the display (IMAGE 3).
- Press the controller briefly.
The display will change to the 'rear view & 360 panoramic view' (IMAGE 4).
- Press the controller briefly again.
The display will switch to the 'rear view & side view' (IMAGE 5).
- Disengage the reverse gear to exit the 360 camera mode.

LANGUAGE SETTINGS

- Access the vehicle's 'Media Information' menu.
- Hold down the '360 Button Controller' for about 8 seconds.
- The '360 Language' prompt will appear with the default language displayed.
- Press the '360 Button Controller' briefly to cycle through the available languages as listed below.
- If no action is taken for 8 seconds, the language mode will exit automatically, and the display will show the selected language.

**1.English | 2.German | 3.French | 4.Spanish | 5.Italian
6.Dutch | 7.Portuguese | 8.Swedish | 9.Norwegian**



IMAGE 1



IMAGE 2



IMAGE 3

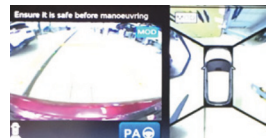

IMAGE 4



IMAGE 5